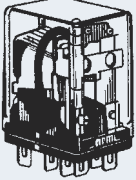

CONTENTS

Misc. Special Relays66
R10, Potter & Brumfeld68
High Current Power68
Coaxial Relays: Switches & Misc. . .	.69
Tohtsu70
Vacuum Relays72
Amperite Thermal Delay72

Misc. Special Relays 12VDC Coil unless otherwise indicated.

Fig. Photo	Part #	Style	Type	Coil VDC	Coil Ω	Amp	L x W x H (inches)	Mfg. / Notes	Price
C 	LZN2-12V	Flatpack	DPDT	2.0	12	480	1.2x0.8x0.4	Omron / Hurricane 350	\$ 24.95
	NF2-12V	Flatpack	DPDT	2.0	12	480	1.2x0.8x0.4	Aromat / Hurricane 350	22.95
	LZN2-US	PCB	DPDT	12	500	2	-	- / Hurricane 350	22.95
	NC2ED-JP-DC12V	PCB	DPDT	12	415	5	-	Aromat / -	12.95
D 	171-1X-7635	Open Frame	SPST	12	100	20	1.8x1.0x1.3	Deltrol	14.95
	RLY8512	Open Frame	SPST	12	100	30	1.8x1.0x1.3	Philips/ECG / W88KDX-2	19.95
	KA11DG-12V	Open Frame	DPDT	12	120	10	1.7x1.0x1.2	P & B / -	14.95
	1819-16	Open Frame	DPDT	12	240	10	1.7x1.0x1.2	- / -	11.95
	KA11AG	Open Frame	DPDT	24vac	75	10	1.7x1.0x1.2	P & B / -	19.95
E 	RLY1425	Open Frame	SPDT	120VAC	-	-	1.7x1.0x1.3	ECG / -	10.95
	KA14AY-120	Open Frame	3PDT	120VAC	-	5	1.7x1x1.3	P & B / -	19.95
	MK305	Open Frame	KPDT	100	6.8k	5	-	- / -	24.95
	KA1538	Open Frame	DPDT	110	7.2k	5	1.7x1.0x1.2	P & B / -	24.95
	KA11DG	Open Frame	DPDT	110	9k	10	-	P & B / -	24.95
	KA2245	Open Frame	3PDT	110	9k	5	2.1x1.5x1.3	P & B / -	24.95
	16010010	Open Frame	3PDT	110	9.5k	5	1.8x1.0x1.2	- / -	14.95
	3PDT10A110v	Open Frame	3PDT	110	8.2k	10	1.8x1.1x1.3	- / Interchange.	24.95
	303D10	Open Frame	3PDT	110	10k	10	1.9x1.0x1.3	CDE / Astro, Atlas	24.95
	CA14D10	Open Frame	3PDT	110	10k	8	1.7x1.6x1.2	Schrack / -	19.95
F 	R14-11D-12	Enclosed	DPDT	10	165	-	-	NTE / -	18.95
	DPDT-12v	Enclosed	DPDT	12	160	10	1.6x0.8x1.1	- / -	18.95
	ITT4B841R	PCB	4PDT	12	170	3	1.6x0.8x1.1	ITT / -	5.75
	MY4-02	PCB	4PDT	12	150	5	1.6x0.8x1.1	Omron / RLY7062P	5.75
	C281XDX	Term	4PDT	12	150	5	-	Swan / -	13.95
FF 	LY2-UA-006244	Enclosed	DPDT	120VAC	4k	12	1.1x0.8x1.4	FSP / Vert Mt, Term up	14.95
	268DPDT-24	Enclosed	DPDT	24	250	15	2x1.5x1.3	Deltrol / -	13.50
	CRH1530	Enclosed	3PDT	110	9.6k	20	2.1x1.5x1.3	- / -	34.95
	RM202221	Term	DPDT	220	39K	16	1.4x1.5x2.1	- / -	15.95
	MY2	Enclosed	DPDT	115VAC	4.5k	5	1.1x0.8x1.4	Omron / -	19.95
	166P-DPDT	Enclosed	DPDT	12	120	10	1.5x1.3x2.0	Deltrol / -	15.95
	GQ-DPDT-12D	Enclosed	DPDT	12	115	10	2x1.5x1.3	Master / Power/Ant SW	19.25
G 	KRUP110	Enclosed	3PDT	110	8.6K	13	2x1.5x1.3	Kest / Power/Ant SW/SB220	24.95
	CRH153D	Enclosed	3PDT	110	10K	10	2x1.5x1.3	Line Elec / Power/Ant SW	34.95
	188-25B2U1	Enclosed	SDDT	12	120	30	2x1.5x1.3	- / Power/Ant SW	6.35
	KUMP-14D18-110	Enclosed	3PDT	110	10K	15	2x1.5x1.3	P & B / SB220 Substitute	24.95
	KRUP240	Enclosed	3PDT	240VAC	6.7K	13	2x1.5x1.3	Kest / -	15.95
GG 	A283XCX252	Enclosed	3PDT	24	460	5	2x1.5x1.3	MSD / Power/Ant SW	22.95
	RLY1943F	Enclosed	DPDT	24	450	16	2x1.5x1.3	ECG / Power/Ant SW	19.95
	RG2E-5V	PCB	DPDT	5	-	1	1x0.9x0.4	Aromat / -	7.95

Misc. Special Relays

Fig.	Photo	Part #	Style	Type	Coil VDC	Coil Ω	Amp	L x W x H (inches)	Mfg. / Notes	Price
F		204801-928	PCB	DPDT		200	2	-	Old Outcom	19.95
		T-DC-12P	Term	DPDT	12	100	5	-	Teledyne / Early KLM	24.95
I		221D012	PCB	DPDT	12	300	2	-	- / -	9.95
		244DN0-12/02C	PCB	DPDT	12	300	2	Sealed	- / Similar to FBR244D012	9.95
J		FBR244D012	PCB	DPDT	-	-	-	-	- / -	9.95
		DS1E-ML2-DC12V	PCB	SPDT-BM	12	400	2	0.6x0.4x0.4	Low Signal, 2 Coil Latching	5.50
		DSBT-S-D05V	PCB	DPDT	5	70	2	-	NAIS / -	3.95
		NRHD-12V	PCB	SPDT	12	1K	-	0.9x0.4x0.4	Matsushita / Fast RF reed	13.70
		RSD-12V	PCB	DPDT	12	890	-	-	Aromat / 150W Fast RF reed	11.00
		RZ12	PCB	DPDT	12	285	2	-	- / -	Call
		190-22B100	PCB	DPDT	12	300	2	-	Midtex / Sub for RZ12	10.95
		DS2E-M-DC12V	PCB	DPDT	12	360	2	0.8x0.4x0.4	-	3.75
		DS2Y-S-DC12V	PCB	DPDT	12	720	/	-	NAIS / -	4.95
		N4078-2C-12V-0.2	PCB	DPDT	12	730	2	0.8x0.4x4.8	NHG	3.95
K		JY1J-DC12V	PCB	SPDT	12	355	5	0.8x0.4x0.8	Aromat / -	3.95
		W76URCPCX-16	PCB	SPDT	12	290	10	-	Magnecraft / -	7.95
		JR1-DC12V	PCB	SPDT	12	280	10	-	Aromat / -	7.95
		JR2A-DC12V	PCB	DPST	12	280	5	-	Aromat / -	7.95
		JW2EN-12V	PCB	DPDT	12	280	5	1.1x0.5x0.8	Aromat / Messenger	3.50
		621D012	PCB	DPDT	12	300	5	1.1x0.5x1.0	- / -	8.95
		VB12TCU	PCB	DPDT	12	-	5	1.1x0.5x1.0	Messenger	621D012 sub
		GR2-214-V-US	PCB	DPDT	12	-	5	1.1x0.5x1.0	- / -	621D012 sub
		G2R-117P-V-US	PCB	SPDT	24	1.1K	10	1.1x0.5x1.0	Omron / -	6.95
		G2R-1-E	PCB	SPDT	24	1.1K	16	1.1x0.5x1	Omron / -	4.45
G2R-14-120VAC	PCB	SPDT	120VAC	7.2K	10	1.1x0.5x1.0	Omron / Sealed	-		
L		W171DIP-4	PCB	-	12	-	-	-	Magnecraft / -	8.95
		W172DIP-3	PCB	-	12	-	-	-	Magnecraft / -	8.95
		W172DIP-19	PCB	-	12	-	-	-	Magnecraft / Atlas 350XL	9.95
N		A410.364382	PCB	DPDT	6	-	-	-	Guardian / Good for 2 KW	15.95
		A410.364385	PCB	DPDT	12	150	5	1.1x1.1x1.0	Guardian / Good for 2 KW	18.95
		A410.364388	PCB	DPDT	24	600	5	24V	Guardian / Good for 2 KW	18.95
O		JWD-172-162	PCB	-	-	-	-	P & B / -	6.00	
P		TSP154-C-C	PCB	DPDT	29VDC	185	2	.5x1x1.125	Gould Allied / -	12.95
		T154X-356	TERM	DPDT	29VDC	185	5	.5x1x1.125	Allied Control / -	12.95
Q		MR62-12USRY	PCB	DPDT	12	365	2	-	NEC / Sub for RZ12	6.95

R10 Style Relays P&B, American Zettler, Aromat

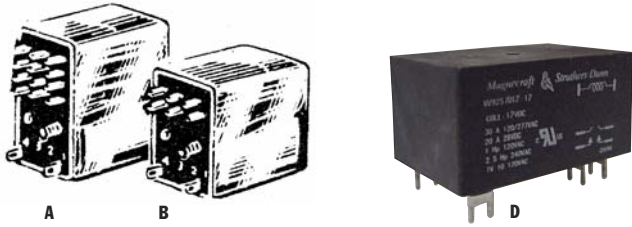

R10 Style RELAY SOCKETS

Stock #	No. Poles	Terminal	Price
27E125	2	Solder	\$1.50
27E126	4	Solder	1.75
27E128	2	PC	1.50
27E129	4	PC	1.75

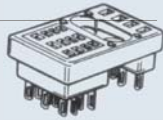

Order #	Fig.	Style	Type	Amp	VDC	Ω	Notes	Price
R10E1W4V185	A	Enclosed	4PDT	7.5	12	185	Term	\$19.95
R104PDT-PC	A	Enclosed	4PDT	2	12	185	Generic PCB	16.95
R104PDT-T	A	Enclosed	4PDT	2	12	185	R10E1 Term	16.95
R10E1X4V185	A	Enclosed	4PDT	5	12	185	Term	18.95
R10E1Y4V185	A	Enclosed	4PDT	2	12	185	R104PDT-T	16.95
R10E2358-2	A	Enclosed	4PDT	7.5A	12	185	use R101E1W4V185	-
R10E4341-1	A	Enclosed	3PDT	10	12	185	Special	27.90
R10E4371.1	A	Enclosed	DPDT	10	12	185	Special	38.00
AZ421-1011-1T	A	Enclosed	4PDT	7.5	12	185	Term	16.95
AZ421-V12-203	A	Enclosed	4PDT	5	12	110	Term	16.95
4T12V-9	A	Enclosed	4PDT	2	12	185	use R104PDT-PC	-
R10DPDT-PC	B	Enclosed	DPDT	2	12	185	Generic R10E2 PCB	13.90
R10DPDT-T	B	Enclosed	DPDT	2	12	185	Generic R10E1 Term	13.90
R10E1W2V185	B	Enclosed	DPDT	7.5	12	185	Enclosed, Term	17.95
24A12C20E	B	Enclosed	DPDT	2	12	900	PCB, ITT	7.95
AZ428.80.200	B	Enclosed	DPDT	2	12	420	PCB	7.95
AZ428.1011.4LD	B	Enclosed	DPDT	2	12	180	PCB make-before-break	7.95
AZ420-V10-4H	B	Enclosed	DPDT	2	12	200	same as R10DPDT-T	
AZ428-1011-4LB	B	Enclosed	DPDT	2	12	185	Term, Special make-before-break	9.95
AZ428220200	B	Enclosed	SPDT	2	12	220	PCB	6.95
K2T-12V-9	B	Enclosed	DPDT	1		530	PCB	13.90
K2YT-12V-9	B	Enclosed	DPDT	2	12	180	PCB	13.90
W92S7D12-12	D	Enclosed	DPDT	30	12			9.95

Relay and Prewired Socket

40A, SPDT. Socket has 10" leads.



Relay Part #: RL5 Price: (1-9) \$2.95 ea.
(10-UP) 2.39 ea.

Socket Part #: RL5-SOC Price: (1-9) \$2.95 ea.
(10-UP) 2.39 ea.

High Current Power Relays



photo
coming
soon

Part #	Fig.	Mfg.	Coil Volts	Res.	Cont. Type	Contact Rating	Price
W102VX	A	5KV Peak, 10mA, SPST-N/O				Reg. \$89.50, Special:\$69.50	
PRDA-11AYB-24	B	P&B	24 VAC		DPDT ³	25A 120/240 VAC	29.95
W199X-12 ¹	C	Magnecraft	12 VDC	70	DPDT	30A 28 VDC/300 VAC	32.95
W199X-7 ¹	D	Magnecraft	12 VDC		DPST	30A 28 VDC, 300 VAC	32.95
W99AX5 ¹	F	Magnecraft	115 VAC	280	DPDT	25A, 115/230 VAC	24.95
W199AX-14P	C	Magnecraft	120 VAC		DPDT	25A	24.95
PRD-7DG1 ¹	D	P&B	24 VDC		DPDT	30A, 240 VAC/ 10A, 600 VAC	27.95
PRD11DY0-24 ¹	C	P&B	24 VDC		DPDT	25A, 240 VAC/ 20A, 277 VAC	27.95
76826 ¹	C	DOVER	24 VDC		DPDT	25A, 240 VAC/ 20A, 277 VAC	27.95
2160B430JA	F	Rowan	24-28 VDC		3PST		29.95
302-13B200	G	MIDTEX	12 VDC		DPST ⁴	30A, 277 VAC	24.95

¹ Limited Supply ² used, excel. condition ³ with SPDT Microswitch ⁴ Normally closed contacts

3 phase relays and additions to the High Current Relay line will be posted in our online Catalog at: www.rfparts.com

Coaxial Relays & Switches

115 VAC
SPDT (3)

Type-N (F) Connectors
Mfg. Amphenol
MIL# 5985-557-6117

Part #: 316-10732-8
Price: \$99.80 ea.



24 VDC
SPDT

Type-N Connectors
Mfg. Narda

Part #: 023-A2-D1C-0B0
Price: \$359.00

Data Sheet is available at
www.rfparts.com



115 VAC
SPDT

Type-N Connectors
Dow-Key Type
2KW PEP, 1KW CW
Isolation 50dB@30MHz,
32dB@400MHz, 24dB@1GHz.

Part #: 6350-6
Price: \$99.95 ea.

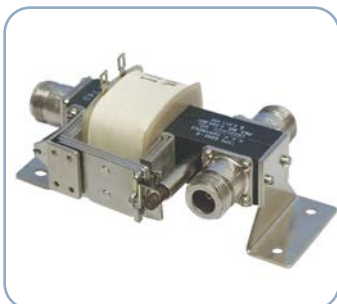

24VDC (20-28VDC)
SPDT

Type-N Connectors
Mfg. Relcomm Technologies

Part #: RDL-SR012
Price: \$295.00 ea.

Data Sheet is available at
www.rfparts.com



24 VDC
SPDT

Type-N Connectors
Mfg. Dow-Key

Part #: 402A-280132
Price: \$435.00

Data Sheet is available at
www.rfparts.com



15 VDC
SPDT (3)

Type-N (F) Connectors
Mfg. RLC Electronics

Part #: S2886
Price: \$149.00

Data Sheet is available at
www.rfparts.com



26 VDC
SPDT

BNC (F) Connectors
Mfg. Joslyn

Part #: 318-010407-3
Price: \$59.95

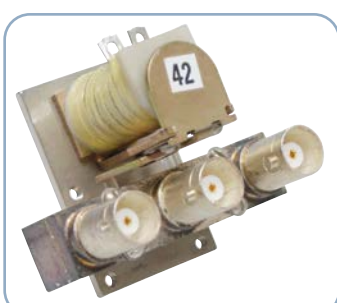

Coaxial Vacuum Relay

26.5 VDC
SPDT
5KW @ 30MHz
LC (F) Connectors
Mfg. Jennings

Part #: RC43E6051H440
Price: \$595.00



26.5 VDC
SPDT

BNC (F) Connectors
Mfg. Amphenol

Part #: 300-11399
Price: \$129.95



Vacuum Relay Assembly

20 / 115VAC
Mfg. Jennings

Part #: 9975761
Price: Call (used)



Tohtsu® Coaxial Relays Coil Voltage 12VDC unless noted.

Part No.	Contacts	Notes	Connection		12VDC Coil Ω	CW Power @ MHz				Isolation -dB (min)				Insertion Loss dB (max)			
			NO/NC	COM		50	150	500	1000	50 MHz	150 MHz	0.5 GHz	1.0 GHz	50 MHz	150 MHz	0.5 GHz	1.0 GHz
CX-120A	SPDT		Note 1	Note 1	150	250	200	150	150	60	50	40	29	.05	0.1	0.2	.25
CX-120P	SPDT		PCB	PCB	150	250	200	150	150	60	50	40	29	.05	0.1	0.2	.25
CX-121B	SPDT		Note 1	Note 1	150	250	200	150	150	60	50	40	29	.05	0.1	0.2	.25
CX-140D	SPDT	3	Note 1	N	150	250	250	250	150	55	51	47	34	.08	0.1	.15	0.2
CX-140M	SPDT		Note 1	UHF	150	250	250	250	150	55	51	47	-	.08	0.1	.15	-
CX-230	SPDT		BNC	BNC	75	300	300	300	200	56	42	30	24	.05	.05	1.0	0.2
CX-230-24	SPDT	5	BNC	BNC	24V 75	300	300	300	200	56	42	30	24	.05	.05	1.0	0.2
CX-230L	SPDT		BNC	BNC	75	300	300	300	200	56	42	30	24	.05	.05	0.1	0.2
CX-520D	SPDT	3,4	N	N	75	350	300	300	250	65	60	53	46	0.1	.15	.18	0.2
CX-530D	SPDT		BNC	N	75	350	300	300	250	65	60	53	46	0.1	.15	.18	0.2
CX-531M	SPDT		Note 1	UHF	75	200	200	150	-	65	65	40	-	.15	.15	0.2	-
CX-531N	SPDT	3	Note 1	N	75	200	200	150	100	65	65	40	20	.15	.15	0.2	.25
CX-540D	SPDT	3,4	BNC	BNC	75	350	300	300	250	65	60	53	46	0.1	.15	.18	0.2
CX-550F	SPDT	3,4	F (75Ω)	F	75	250	250	200	150	70	65	53	50	0.1	.12	.14	.19
CX-560D	SPDT	3,4	TNC	TNC	75	350	300	300	250	65	60	53	46	0.1	.15	.18	0.2
CX-600M	SPDT		UHF	UHF	75	1000	1000	800	-	60	48	37	-	.07	0.1	0.1	-
CX-600N	SPDT	3	N	N	75	1000	1000	800	500	60	48	37	28	.07	0.1	.15	0.2
CX-600N-24	SPDT	3,5	N	N	24V 300	1000	1000	800	500	60	48	37	28	.07	0.1	.15	0.2
CX-600NC	SPDT	3	Note 2	N	75	1000	1000	800	500	60	48	37	28	.07	0.1	.15	0.2
CX-600NL	SPDT		N	N	75	1000	1000	800	500	60	48	35	28	.07	.09	0.1	.15
CX-800M	DPDT	3	UHF	UHF	48	1000	1000	800	500	50	48	37	28	.15	.15	0.2	0.2
CX-800N	DPDT	3	N	N	48	1000	1000	800	500	50	48	37	28	.15	.15	0.2	0.2
CX-800N-24	DPDT	3,5	N	N	24V 192	1000	1000	800	500	50	48	37	38	.15	.15	0.2	0.2
CX-800NC	SPDT	3	Note 2	N	48	1000	1000	800	500	50	48	37	28	.15	.15	0.2	0.2
CX-1054A	SPDT	3	Note 1	N	120	250	250	200	150	55	51	47	34	.08	0.1	.15	0.2
CZX-3500	SPDT	3	N	N	48	1000*	1000*	800	600	65	65	65	65	0.1	0.1	0.2	.25

Notes:

*watts P.E.P.

1. Direct coax cable connection. Will accept the following cables: RG58A/U, RG142, LMR-195, 2.5D2V.
2. Direct coax cable connection. Designed for 0.312" (max.) O.D. coax (type 5D)

3. Some models have specifications through 6 GHz. Contact us for additional information.

4. N.O. Contacts grounded.

5. Coil rating 24VDC.



Relays with 24 VDC coil are available on special order. All connectors are female connection.

Additional Coil Data

Life expectancy 1,000,000 Operation (min.)

Part Number	Nominal Vdc	Activation Data (Vdc)		Switching Time	
		Pull in	Drop Out	Pull in	Drop Out
CX-120A	12	9 - 15	1.5	20ms	15ms
CX-120P	12	9 - 15	1.5	20ms	15ms
CX-121B	12	9 - 15	1.5	20ms	15ms
CX-140D	12	9 - 15	1.5	15ms	10ms
CX-140M	12	9 - 15	1.5	15ms	10ms
CX-140N	12	9 - 15	1.5	15ms	10ms
CX-230	12	9 - 16.5	1.5	20ms	15ms
CX-230-24	12	9 - 16.5	1.5	20ms	15ms
CX-230L	12	9 - 16.5	1.5	20ms	15ms
CX-520D	12	9 - 16.5	1.5	20ms	15ms
CX-530D	12	9 - 16.5	1.5	20ms	15ms
CX-531M	12	9 - 15	1.5	20ms	15ms
CX-531N	12	9 - 15	1.5	20ms	15ms
CX-540D	12	9 - 16.5	1.5	20ms	15ms
CX-550F	12	9 - 16.5	1.5	20ms	15ms
CX-560D	12	9 - 16.5	1.5	20ms	15ms
CX-600M	12	9 - 16.5	1.5	20ms	15ms
CX-600N	12	9 - 16.5	1.5	20ms	15ms
CX-600NC	12	9 - 16.5	1.5	20ms	15ms
CX-600NL	12	9 - 16.6	1.5	20ms	15ms
CX-800M	12	10 - 14	1.5	20ms	15ms
CX-800N	12	10 - 14	1.5	20ms	15ms
CX-800NC	12	10 - 14	1.5	20ms	15ms
CX-1054A	12	9 - 15	1.5	15ms	10ms
CZX-3500	12	10 - 14	1.5	20ms	18ms

Pricing

Part No.	Our Price	Part No.	Our Price
CX-120A	\$35.00	CX-550F	113.00
CX-120P	35.00	CX-560D	113.00
CX-121B	45.00	CX-600M	 98.95
CX-140D	59.95	CX-600N-12	 98.95
CX-140M	49.95	CX-600N-24	119.00
CX140-N	63.00	CX-600NC	109.00
CX-230-12	79.00	CX-600NL	109.00
CX-230-24	89.00	CX-800M	159.00
CX-230L	109.00	CX-800N-12	159.00
CX-520D	98.00	CX-800N-24	169.00
CX-530D	97.75	CX-800NC	169.00
CX-531M	75.00	CX-1054A	61.00
CX-531N	75.00	CZX-3500-12	139.00
CX-540D	113.00	CZX-3500-24	149.95

Call for quantity pricing.

CX-120A 12 VDC



CX-120P 12 VDC

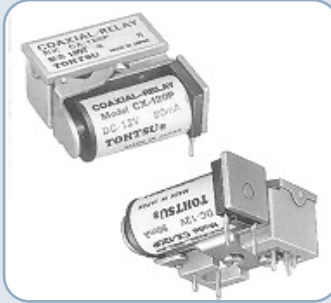

CX-140D 12 VDC



CX-140D 12VDC Coil
CX-140M (SO-239 Connector)
CX-140N 12VDC Coil

CX-230 12 VDC



CX-230 12VDC Coil
CX-230-24 24VDC Coil

CX-520D 12 VDC



CX-530D 12 VDC

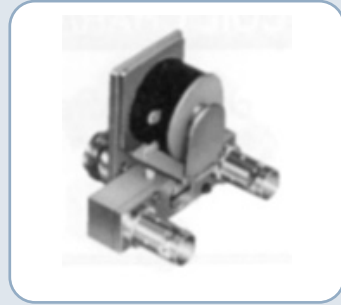

CX-531N 12 VDC

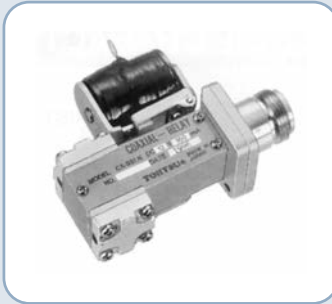

CX-540D 12 VDC

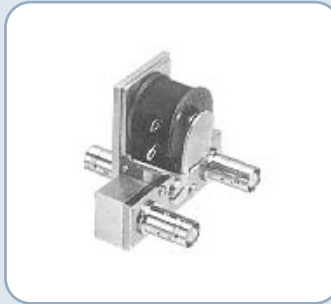

CX-600M (UHF) 12 VDC

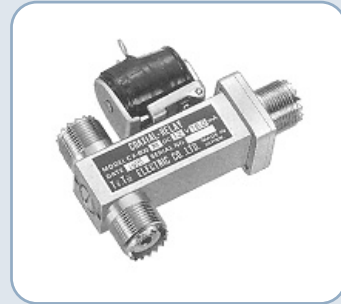

CX-600N



CX-600N 12VDC Coil
CX-600N-24 24VDC Coil

CX-600NL 12 VDC



CX-800M 12 VDC



CX-800N



CX-800N 12VDC Coil
CX-800N-24 24VDC Coil

CX-1054A 12 VDC

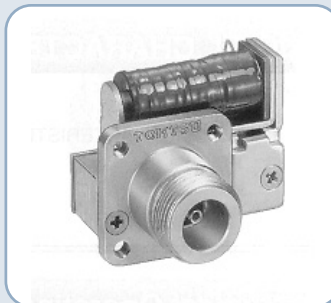

CZX-3500



CZX-3500 12VDC Coil
CZX-3500-24 24VDC Coil

RELAYS

Vacuum Relays

for High Power Antenna Switching



VHC1



VC2F Flange Mount



VC2T Threaded Base

Model	Mfg.	Coil Voltage DC Volts	Coil Resist. Ohms	Maximum Continuous Current (RMS)				Vol Peak Test Max	Peak Operating Voltage Between Contacts & to Base (15 µA Max Leakage)				Contact Resistance (Max) Ohms	Price (1-9)
				dc or 60Hz	2.5 MHz	16 MHz	32 MHz		dc or 60Hz	2.5 MHz	16 MHz	32 MHz		
VC2T-13.2	RF Parts	13.2	85	50	30	17	10	17	15	12	9	7	0.012	\$ 97.50
VC2F-13.2	RF Parts	13.2	85	50	30	17	10	17	15	12	9	7	0.012	97.50
VC2T-28.6	RF Parts	26.5	265	50	30	17	10	17	15	12	9	7	0.012	97.50
VC2F-28.6	RF Parts	26.5	265	50	30	17	10	17	15	12	9	7	0.012	97.50
VHC1-12V	Greenstone	12												69.95
VHC1-26.5V	Greenstone	26.5												69.95
VHC1-115V	Greenstone	115												Call

RF Parts Similar to: RJ4B, RJ4C, RJ2B, RF2C, RJ6C, KC-2, KC-11. Greenstone similar to: HC-1, HC-3, RJ1A-26S, RJ1H-26S

Misc. Vacuum Relays

Can't find the vacuum relay you're looking for? Visit our website at:

www.rfparts.com/used_equipment.html

We have many new and used vacuum relays in stock mfg. by Kilovac and Jennings.



Amperite Thermal Delay Relays

Call for stock/price check

Octal Base



Normally Open Contacts

Part No.	Volts	Delay /Sec.
6N02	6	2
6N03	6	3
6N05	6	5
6N08	6	8
6N010	6	10
6N015	6	15
6N020	6	20
6N030	6	30
6N040	6	40
6N045	6	45
6N060	6	60

Part No.	Volts	Delay /Sec.
6N090	6	90
6N0120	6	120
6N0150	6	150
6N0180	6	180
12N010	12	10
12N030	12	30
12N060	12	60
12N090	12	90
12N0120	12	120
26N05	26	5
26N08	26	8

Normally Closed Contacts

Part No.	Volts	Delay /Sec.
6C10	6	10
12C120	12	120
26C8	26	8
26C20	26	20
115C2	115	2
115C3	115	3
115C10	115	10
115C30	115	30
115C60	115	60
115C120	115	120
115C180	115	180

9 Pin Miniature



Normally Open Contacts

Part No.	Volts	Delay /Sec.
2N015T	2	15
6N02T	6	2
6N05T	6	6
6N010T	6	10
6N060T	6	60
6N075T	6	75
6N0120T	6	120
6N0150T	6	150
6N0180T	6	180

Part No.	Volts	Delay /Sec.
12N03T	12	3
12N010T	12	10
26N02T	26	2
26N03T	26	3
26N020T	26	20
26N060T	26	60
115N02T	115	2
115N03T	115	3
115N05T	115	5

Normally Closed Contacts

Part No.	Volts	Delay /Sec.
115N07T	115	7
115N020T	115	20
115N030T	115	30
115N045T	115	45
115N060T	115	60
115N075T	115	75
115N090T	115	90
115N0120T	115	120
12C3T	12	3
26C2T	26	2
26C30T	26	30
115C2T	115	2
115C8T	115	8
115C15T	115	15
115C45T	115	45
115C60T	115	60